



AmphiTruck mit Schwerlast-Transporter und Funkmast. Stellt Euch vor, Ihr arbeitet bei einem Telekommunikations-Unternehmen. Für die UMTS-Technologie (neuer Mobilfunkstandard für Handys) müsst Ihr einen Funkmast installieren.

Leider ist es nötig, diesen in unwegsames Gelände zu transportieren. Wie kriegt Ihr den Job hin?

Klar, mit dem fischertechnik-AmphiTruck und einem geländegängigen Schwerlast-LKW, der den Mast so weit wie möglich zum Ziel bringt. Kommt der Laster nicht mehr weiter, übernimmt das Amphibienfahrzeug den Mast und hebt ihn mit seinem Kran vom Transporter.























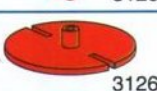

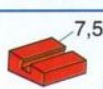

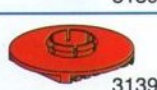

Der Mast wird daraufhin zum künftigen Standort gebracht und dort verankert. Natürlich können diese Geräte noch einiges mehr. Unsere Modelle kannst Du mit den fischertechnik-Baukästen „Super Trucks“ (NEU!) sowie „Power Bulldozer“ konstruieren. Ausserdem lässt sich der AmphiTruck – wie in den jeweiligen Anleitungen beschrieben – für noch mehr Spielspass mit folgendem Zubehör ausstatten: 3 Mini Motor Sets, 2 Power Motor Sets, IR Control Set mit Empfänger 2, Accu Set und Lights.

Beim hinteren Aufbau des Amphibienfahrzeugs sind Eurer Phantasie auch keine Grenzen gesetzt: wie wäre es z. B. mit dem Baggerarm aus dem neuen „Profi Pneumatic II“ statt des Krans? Also: ab ins Gelände!

fischertechnik®

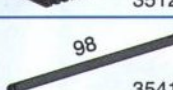

Einzelteilübersicht

| | | | | | | | | | |
|--|-----|--|-----|--|-----|--|------|--|-----|
|  31010 | 4x |  31894 | 1x |  32882 | 9x |  35977 | 3x |  37636 | 22x |
|  31011 | 6x |  31915 | 1x |  32913 | 10x |  35980 | 2x |  37679 | 10x |
|  31013 | 2x |  31916 | 1x |  32968 | 4x |  35998 | 2x |  38225 | 2x |
|  31021 | 2x |  31918 | 2x |  32974 | 4x |  36227 | 40x |  38240 | 8x |
|  31027 | 1x |  31981 | 2x |  34994 | 2x |  36248 | 152x |  38241 | 13x |
|  31030 | 2x |  31982 | 51x |  34995 | 2x |  36293 | 4x |  38242 | 4x |
|  31058 | 2x |  31983 | 9x |  35031 | 2x |  36323 | 10x |  38244 | 4x |
|  31060 | 28x |  31994 | 4x |  35049 | 22x |  36324 | 6x |  38245 | 7x |
|  31061 | 10x |  31997 | 2x |  35050 | 10x |  36334 | 8x |  38246 | 10x |
|  31124 | 2x |  31998 | 2x |  35062 | 1x |  36702 | 2x |  38249 | 4x |
|  31263 | 1x |  31999 | 2x |  35063 | 2x |  36703 | 4x |  38251 | 1x |
|  31264 | 1x |  32064 | 22x |  35064 | 6x |  36819 | 5x |  38253 | 5x |
|  31390 | 1x |  32071 | 2x |  35065 | 15x |  36912 | 2x |  38258 | 12x |
|  31391 | 1x |  32330 | 8x |  35067 | 1x |  36913 | 3x |  38415 | 3x |
|  31422 | 4x |  32850 | 12x |  35072 | 1x |  36914 | 6x |  38423 | 39x |
|  31436 | 4x |  32852 | 1x |  35073 | 6x |  36920 | 10x |  38428 | 10x |
|  31597 | 6x |  32858 | 4x |  35087 | 2x |  36921 | 20x |  38446 | 2x |
|  31690 | 16x |  32859 | 2x |  35088 | 1x |  36922 | 4x |  38464 | 8x |
|  31766 | 4x |  32861 | 2x |  35129 | 6x |  36923 | 2x |  38472 | 1x |
|  31779 | 2x |  32869 | 1x |  35414 | 8x |  36950 | 12x |  78727 | 10x |
|  31790 | 76x |  32870 | 8x |  35797 | 5x |  37237 | 44x | | |
|  31843 | 2x |  32879 | 29x |  35806 | 2x |  37238 | 16x | | |
|  31888 | 2x |  32881 | 40x | | |  37468 | 29x | | |

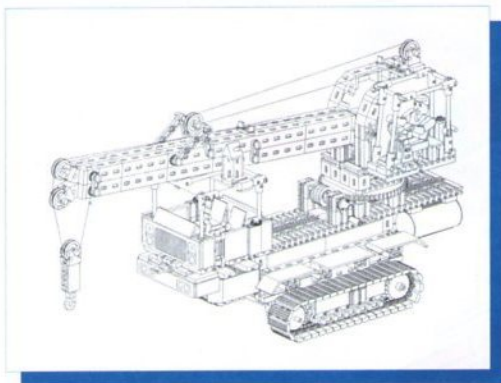

Expeditions-Team

1

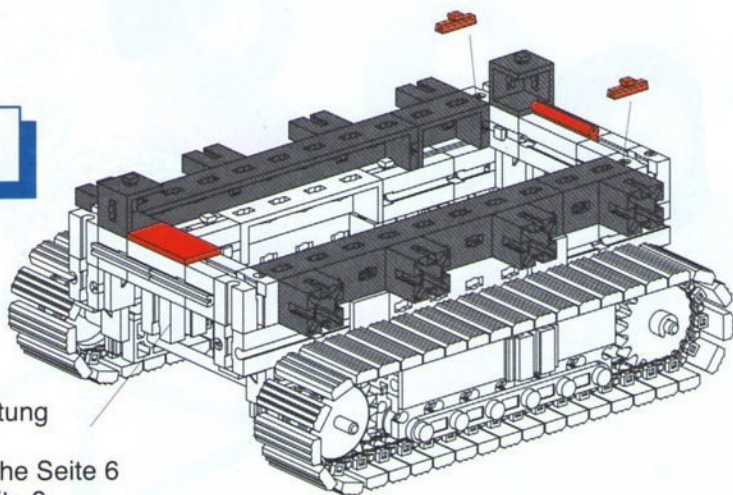

Fahrgestell siehe Bauanleitung
 Power Bulldozer
 Fahrgestell ohne Motor siehe Seite 6
 Fahrgestell mit 1 Motor Seite 9
 Fahrgestell mit 2 Motoren Seite 13

2

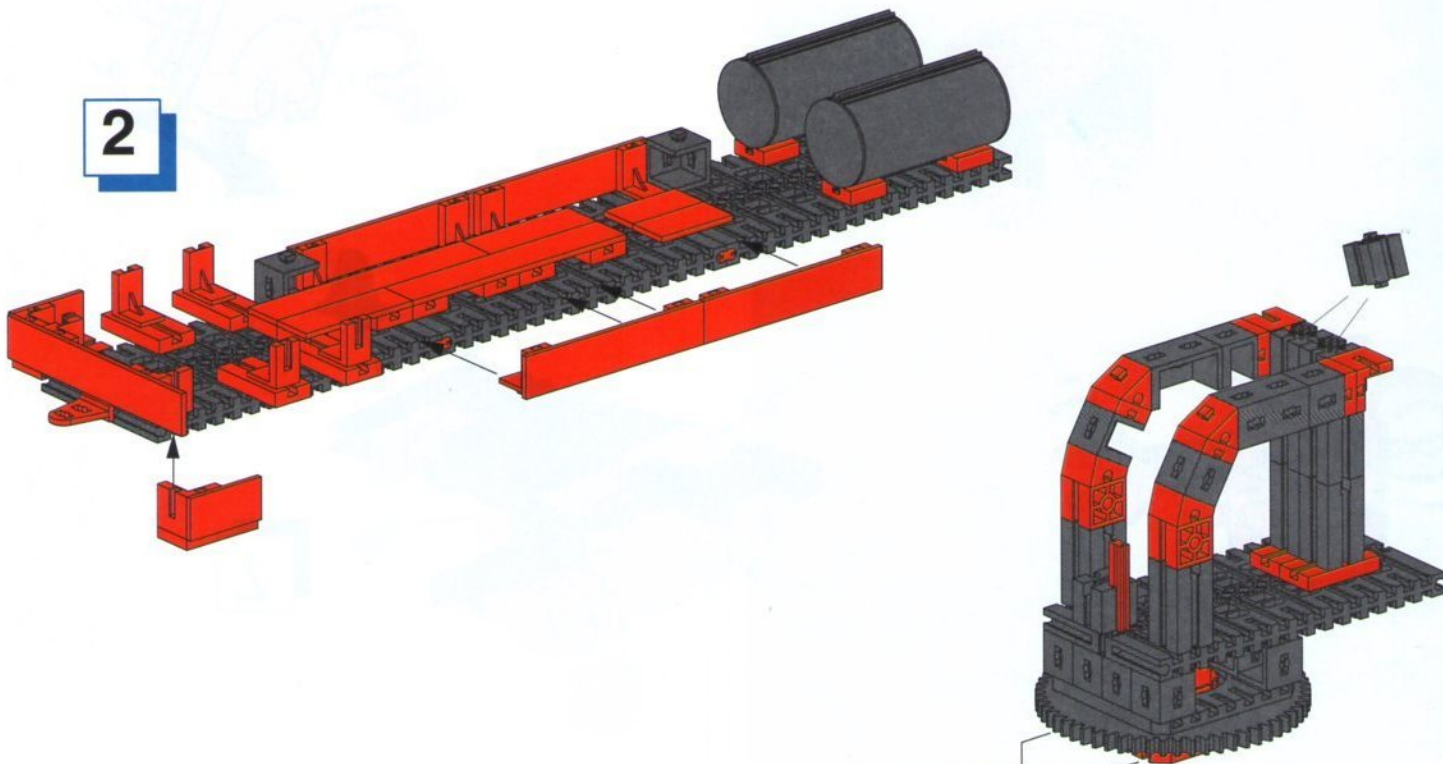

3

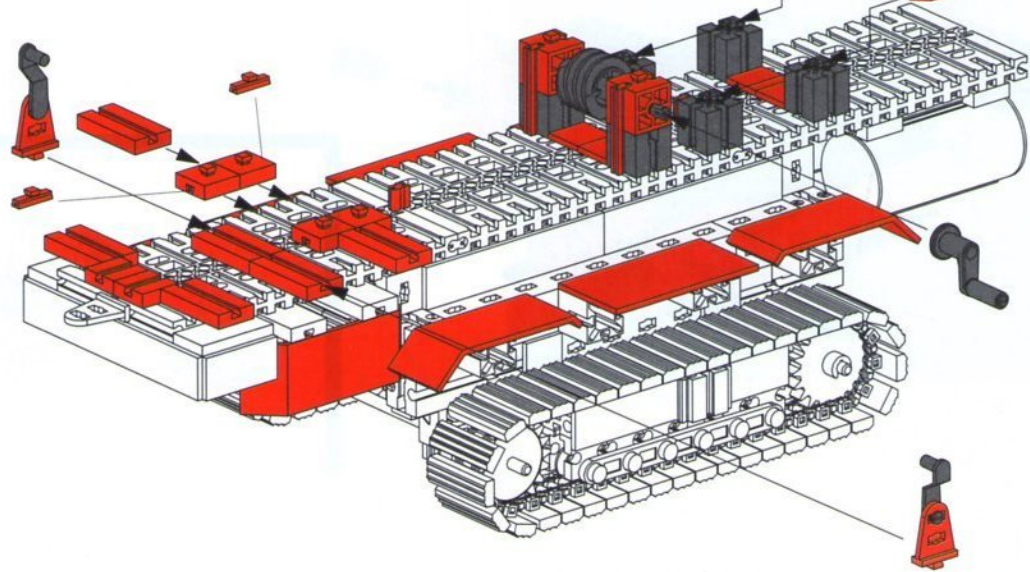

4

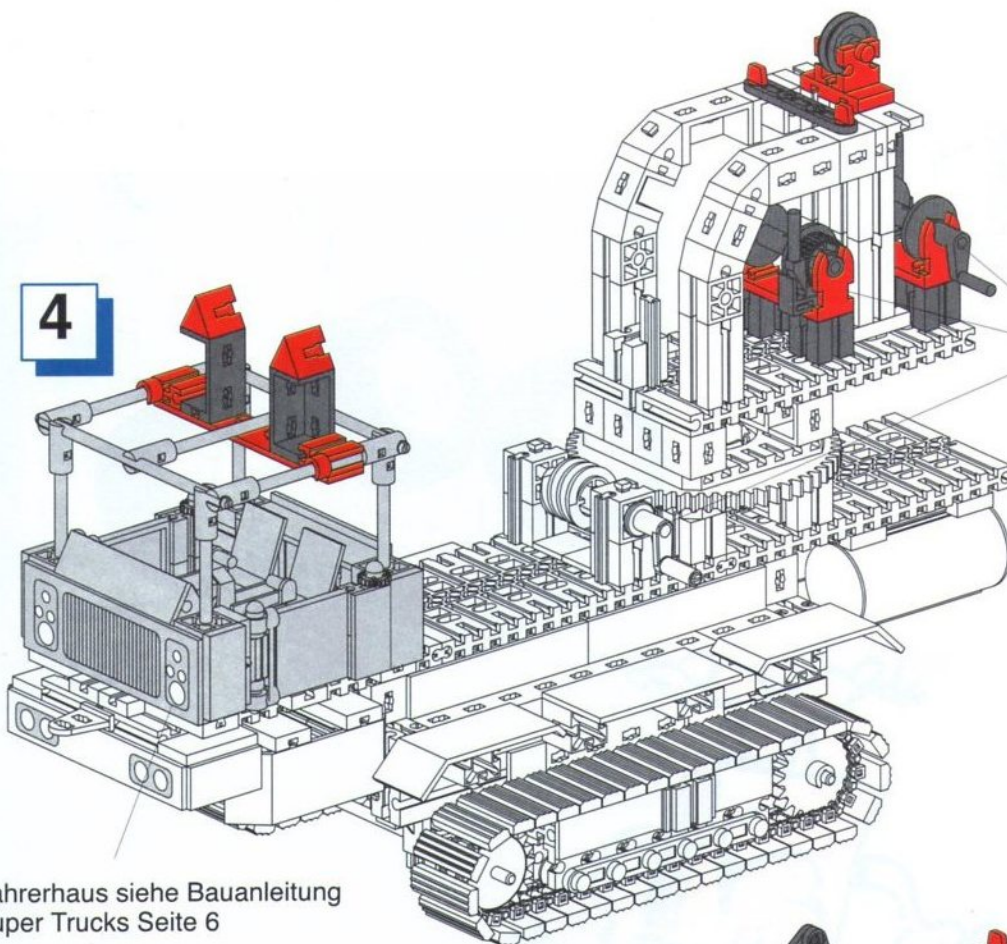

Motorisierung und Fernsteuerung siehe Bauanleitung Super Trucks Seite 78

Fahrerhaus siehe Bauanleitung Super Trucks Seite 6

5

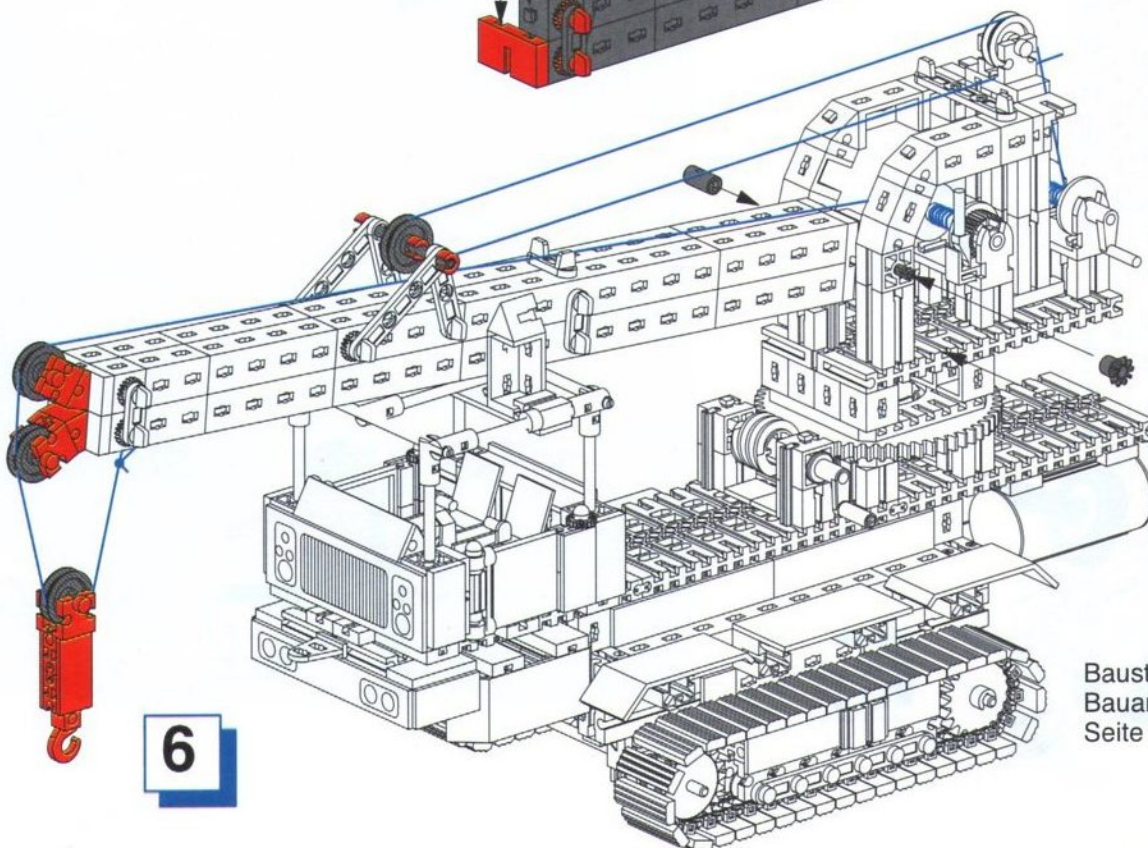
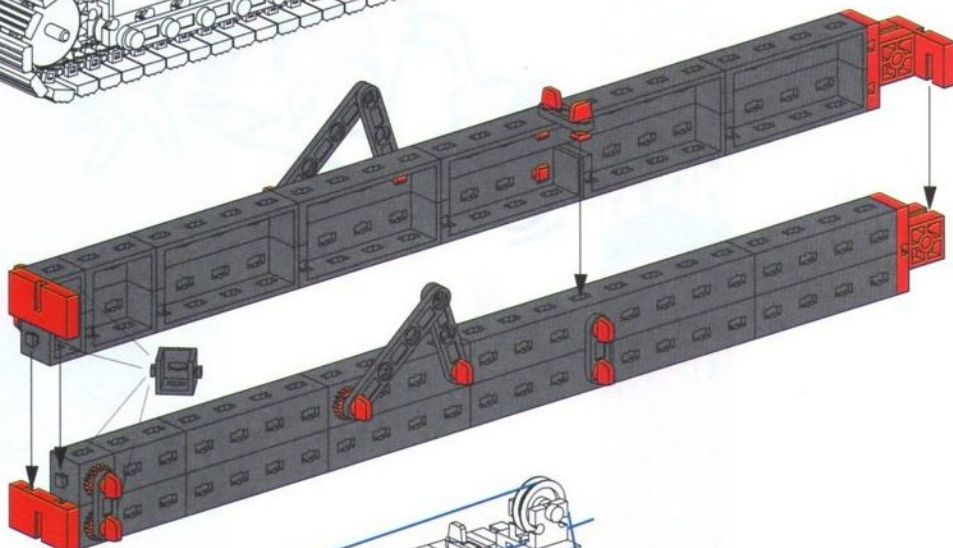

6

Baustufen siehe Bauanleitung Super Trucks Seite 73

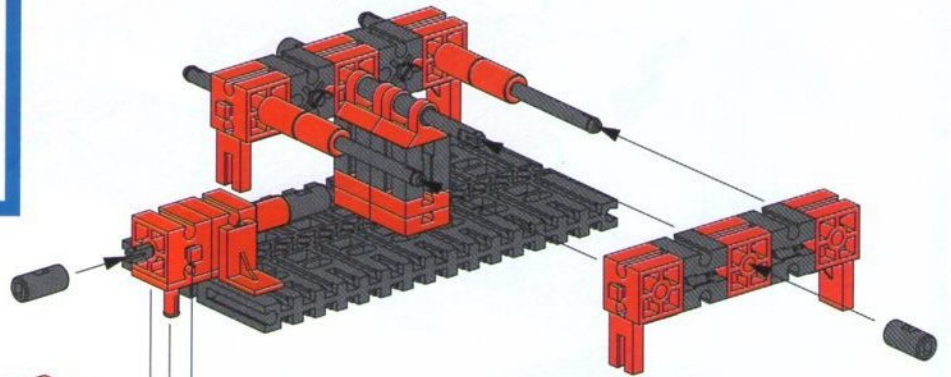
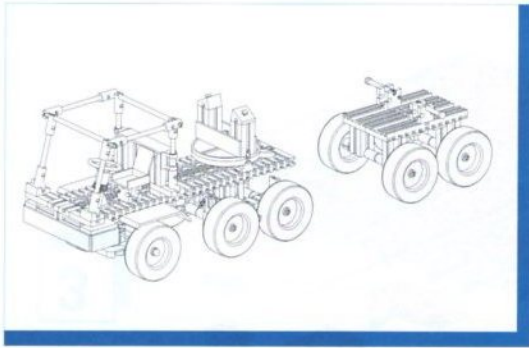

7

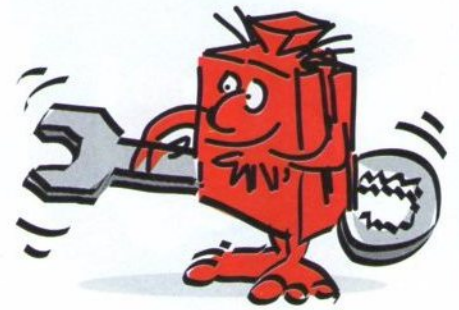
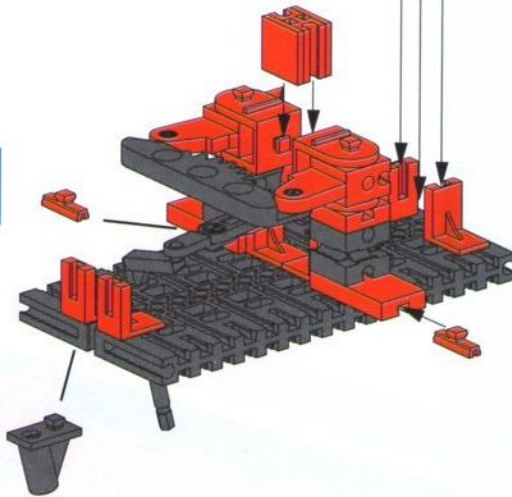

8

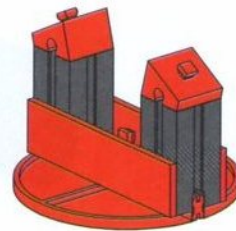

9

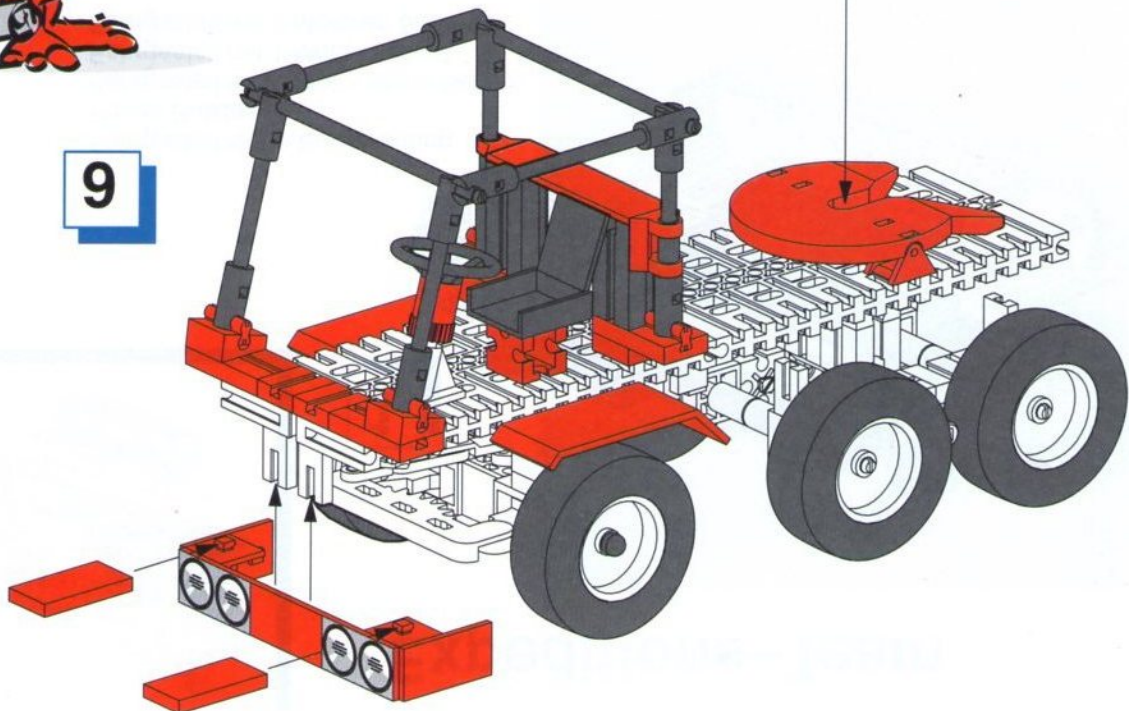

10

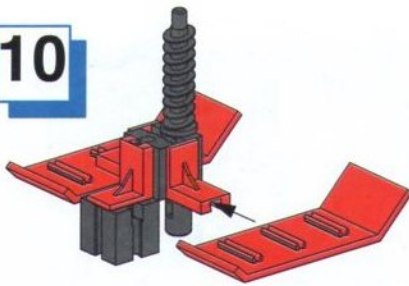

10

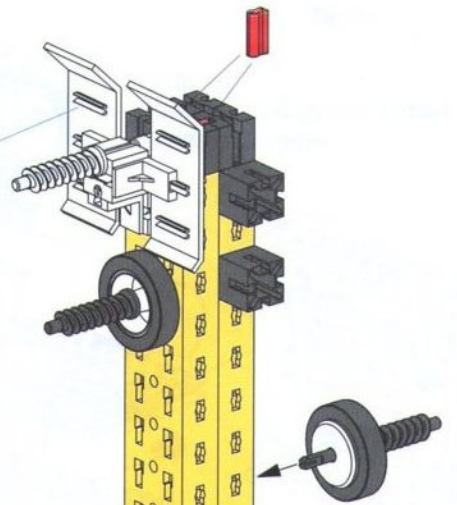

11

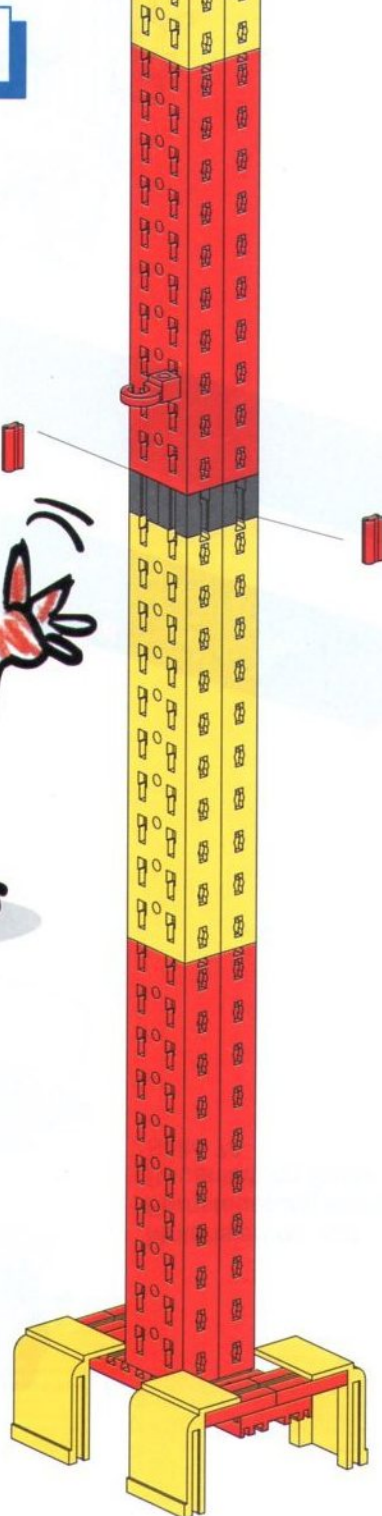

12

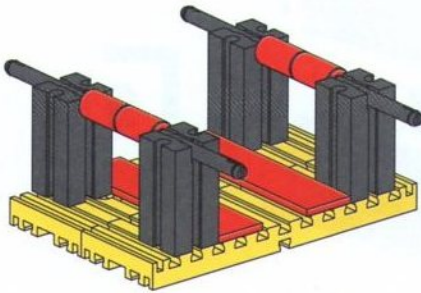

13

